

favorit

The price hit
for a large range of applications.



Key data

The favorit is a CNC universal cylindrical grinding machine for the individual and batch production of short to long-sized workpieces. It has distances between centres of 400 / 650 / 1000 / 1600 mm and a centre height of 175 mm. It can machine workpieces with a maximum weight of 150 kg.

GLOBAL
TECHNOLOGY LEADER
PERFECTION
CUSTOMER FOCUS
EFFICIENCY
SAFETY
SOPHISTICATED PROCESSES
PRECISION

The Art of Grinding.

TECHNOLOGY LEADER
EFFICIENCY
PERFECTION
CUSTOMER FOCUS
PRECISION
GLOBAL
SOPHISTICATED PROCESSES
SAFETY

Fritz Studer AG

The name STUDER stands for more than 100 years of experience in the development and production of precision cylindrical grinding machines. "The Art of Grinding." is our passion, highest precision is our aim and top Swiss quality is our benchmark.

Our product line includes both standard machines, as well as complex system solutions in high-precision cylindrical grinding for machining small and medium-sized workpieces. In addition we offer software, system integration and a wide range of services. As well as receiving a complete tailor-made solution the customer also benefits from our 100 years of know-how in relation to the grinding process.

Our customers include companies from the machine tool industry, automotive engineering, tool and die makers, the aerospace industry, pneumatics/hydraulics, electronics/electrical engineering, medical technology, the watch industry and job order production. They value maximum precision, safety, productivity and longevity. 24000 manufactured and delivered systems make us the market leader and are clear evidence of our technological leadership in universal, external, internal and noncircular grinding. Around 800 employees, including 75 apprentices, make it their goal every day to ensure that "The Art of Grinding." will continue to be closely linked to the name STUDER in the future.

favorit

If you believe that the purchase of a STUDER machine exceeds your budget, then we recommend the favorit. The leader in terms of price and performance can be used in universal applications, and thanks to StuderPictogramming it is easy and quick to program. Your Granitan[®] S103 mineral-casting machine base largely offsets short-term temperature fluctuations.

Characteristics

Dimensions

- Distance between centres 400 / 650 / 1000 / 1600 mm (15.7"/25.6"/39.4"/63")
- Centre height 175 mm (6.9")
- Max. workpiece weight 150 kg (330 lbs)

Hardware

- Optional wheelhead:
 - Turret wheelhead with right or left grinding wheel and an internal grinding attachment. Automatic swiveling with 3° Hirth serration.
 - External wheelhead with grinding wheel on right, 0° / 15° / 30°
- External and internal grinding possible in one setup
- Granitan® S103 mineral-casting machine base
- CE-conform



Software

- Very simple programming thanks to StuderPictogramming
- StuderWINprogramming (optional) for creating grinding and dressing programs on an external PC



The CNC universal grinding machine for small budgets and high demands

This CNC universal cylindrical grinding machine is designed for grinding short to long-sized workpieces in individual and series production. Thanks to various options such as in-process measuring system, balancing system, contact detection and longitudinal positioning, the machine can be adapted to other grinding tasks.

Made of Granitan® S103, the machine bed forms the basis for this cylindrical grinding machine which comes with top-quality components and can be relied on to work for years, while measuring up to the highest standards of precision, performance and safety. The full enclosure provides an optimum insight into the grinding process.

The practical Studer grinding software with its proven StuderPictogramming allows even less experienced users to quickly and practically program grinding and dressing cycles. The systematic development, production, assembly and testing of STUDER products are carried out in a process-oriented manner and in strict compliance with the VDA 6.4 and ISO 9001 directives.



Granitan[®] S103 mineral-casting machine base

1



- Vibration-damping
- Thermally stable
- Non-wearing
- Coolant tank integrated into the machine base

The material structure developed by STUDER which has proved its superb efficiency over many years is produced in the company's own plant using the most modern industrial techniques. The excellent damping properties of the machine base ensure that an outstanding surface quality is achieved in the ground workpieces. The service life of the grinding wheel is also increased, leading to reduced downtimes. Temporary temperature fluctuations are extensively compensated by the favorable thermal behavior of Granitan[®]. This results in a high level of dimensional accuracy throughout the day. The V and flat guideways for the longitudinal and cross slides are molded directly into the machine base and finished with a wear-resistant Granitan[®] S200 surfacing material. The guideways offer the highest possible accuracy through the entire speed range with high load capacity and dampening levels. Thanks to the robust and maintenance-free design, these excellent guideway properties are hardly subject to deterioration.

2

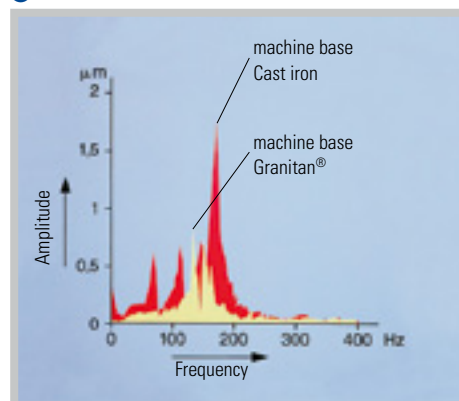

1 Machine base with X and Z guideways

2 Vibration behavior of gray cast iron and Granitan[®] S103

Longitudinal and cross slides

1



2



3



4



- High geometrical traverse precision
- Auxiliary scale for setup and resetting
- Effective covering of guideways

The longitudinal and cross slides are manufactured from high-quality gray cast iron and have highly precise, ground guideways. The slides rest completely on the guideways of the machine bed through the entire traversing range. This provides the cornerstone for the excellent straightness of 0.003 mm (0.000,12") over 1000 mm (39.4") measured length. The top of the longitudinal slide has a surface that is ground over its entire length and acts as a support for the workhead, the tailstock, as well as accessories and devices. A setup scale, recessed in the table, makes it easy to set up and reset the units on the table. An additional T-slot with a ground surface enables the optimal utilization of dressing

devices. The slides are advanced by 40 mm (1.57") diameter circulating ball screws connected to a three-phase servomotor via torsion-resistant, bellow-type couplings.

Wheelhead

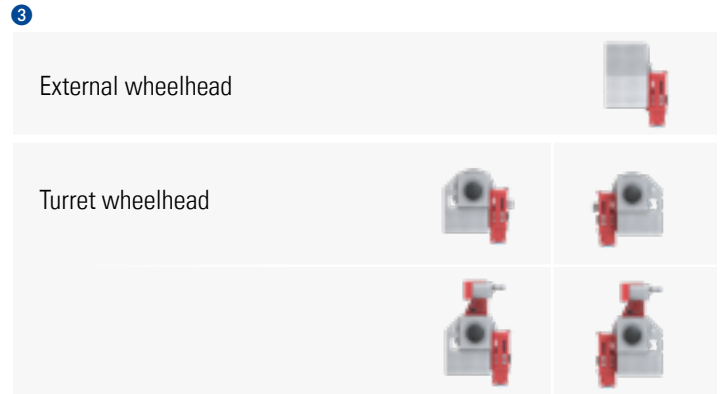

- Complete machining
- Cutting speed up to 50 m/s (9842 sfpm)
- Internal grinding spindle with infinitely variable speed adjustment

Two variants are available:

- Turret wheelhead with right or left grinding wheel and an internal grinding attachment. Automatic swiveling with 3 deg Hirth serration.
- External wheelhead with grinding wheel on right adjustable to 0/15/30 deg.

Grinding wheel size:

diameter 500mm, width 63(80 F5)mm, bore 203 mm (20×2.5" [3.15"F5]×8"). The driving power is 7.5 kW (10 hp). The cutting speed of a maximum 50 m/s (9840 sfpm) enables efficient surface removal rates in the grinding process. The speed of the belt-driven internal grinding spindle is infinitely adjustable. Spindles with nominal rpms of 28 000, 42 000 and 60 000 are available.

Workhead

1



- Pneumatic lifting
- Low maintenance
- High roundness accuracy

1

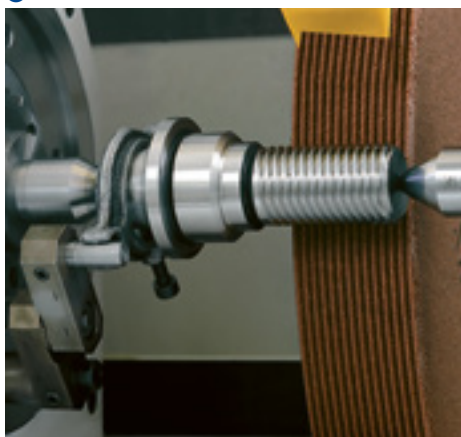

3



The versatile universal workhead enables both live spindle grinding and grinding between centres.

The workhead is equipped with roller bearings, is low-maintenance and has an excellent roundness accuracy of under 0.0004 mm (0.000,016"), which can be optionally improved to under 0.0002 mm (0.000,008") during live spindle operations. The fine adjustment allows for taper corrections in the 1 µm range during live spindle operations. Like the tailstock, the workhead is also equipped with a pneumatic lifting device to facilitate movement during setup and resetting.

The optional C-axis enables thread and form grinding, increasing the machine's potential applications. A controlled power chucking cylinder which actuates power chuck and spring collets is available for automatic workpiece clamping.

4

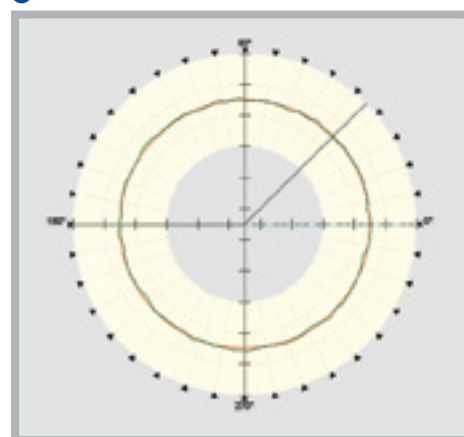

1 Universal workhead

2 External and internal thread grinding

3 Fine adjustment for taper corrections

4 Roundness during live spindle grinding operations

Tailstock

1



2



3

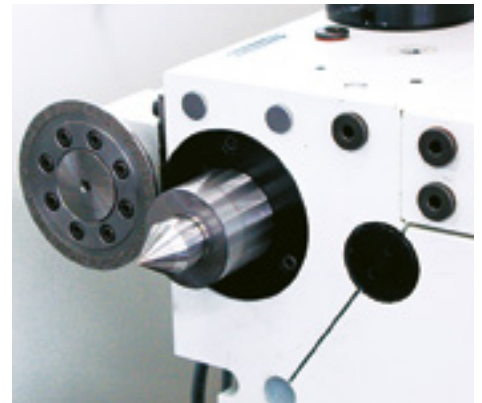

4

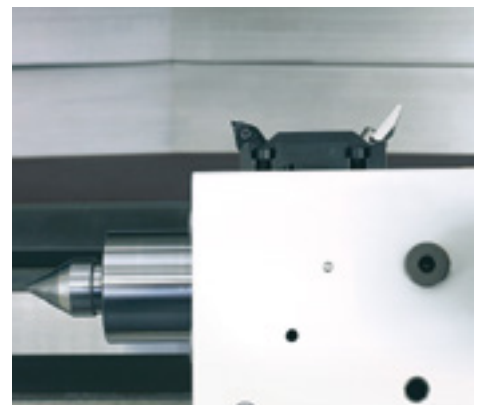

- Taper corrections
- Thermal stabilization by coolant flooding

The generously dimensioned barrel, designed for the use of Morse 3 or 4 taper centres, glides in the tailstock housing.

The centre pressure can be adjusted with the delicate precision required for grinding high-precision workpieces. The tailstock can be equipped with a hydraulically actuated barrel retraction for workpiece change-over. The fine adjustment en-

ables taper corrections in the range below 1 µm when grinding between centres.

In order to guarantee optimum thermal stability, the tailstock is flooded with cooling lubricant, as are the barrel and the diamond holder.

1 Tailstock

2 Fine adjustment for taper corrections

3 Dressing spindle for rotative dressing

4 Dressing tool holder behind tailstock

Control and programming

1



2

- Compact manual control unit
- EMC-tested control cabinet
- Ergonomically arranged controls

The favorit is equipped with a Fanuc Oi-TF. The clearly arranged and ergonomic layout of the control elements ensures efficient operation. The capacitive touchscreen (PCT) is resistant to scratches and dirt thanks to the glass plate that is fitted across the entire panel. It is even easy to operate if the user is wearing gloves. An important role is played by the manual control unit, which facilitates setup close to the grinding process. The control cabinet is located on the left rear of the machine. The layout of the elements complies with the relevant safety norms and is EMC-tested.



StuderWIN

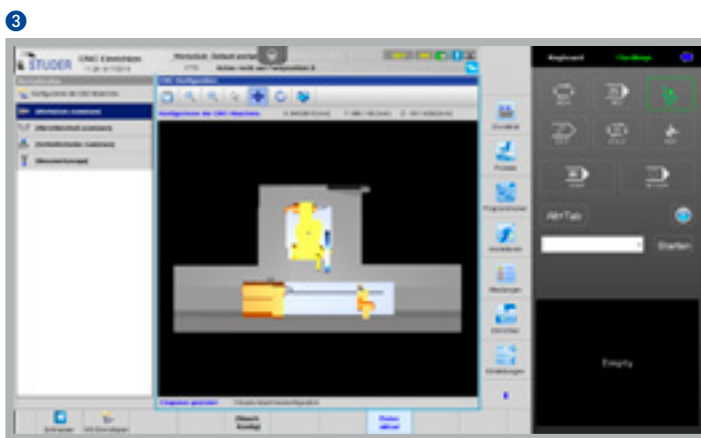
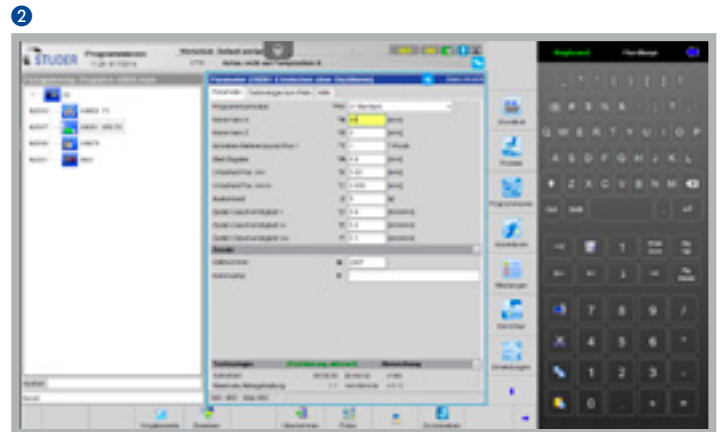

- Latest software technology
- StuderPictogramming
- Integrated peripheral equipment

StuderWIN as the user interface and the integrated software modules create a stable programming environment and contribute to the efficiency of the machine. A PC is integrated into the CNC control. The possibility of fully integrating the in-process measuring system and sensor technology for process control as well as contact detection and automatic balancing systems in the Windows operator interface enables standardized programming of the different systems. The sophisticated mechanical engineering concept of the favorit is completed by a grinding software program developed in-house by Studer and which is continuously optimized in collaboration with users of the software.

This software offers:

- StuderPictogramming: The operator strings the individual grinding cycles together – the control unit generates the ISO code.
- STUDER Quick-Set: The software for grinding wheel alignment reduces changeover times by up to 90 %.
- The functionality of StuderWIN can be extended even more thanks to various enhancements in the form of integrated software modules.
- A valuable asset for the productivity of our customers' machines is StuderTechnology Integrated with the technology computer for automatic calculation of grinding parameters.

The diverse software options can extend the functional scope of the machine. Here are a few examples:

- Microfunctions: Free programming of grinding and dressing process sequences for optimization of the grinding process.

StuderWIN programming, on the basis of StuderWIN, also continues to show its strengths in offline programming. The program is created on the PC and transferred directly to the machine control unit.

Customer care

STUDER cylindrical grinding machines should fulfil the customer's requirements for as long as possible, work cost-effectively, function reliably and be available at all times. From «start up» through to «retrofit» – our Customer Care is there for you throughout the working life of your machine. 30 professional helplines and more than 60 service technicians are available in your area, wherever you are in the world.

- We will provide you with fast, uncomplicated support.
- We will help to increase your productivity.
- We work professionally, reliably and transparently.
- We will provide a professional solution to your problems.



Start up

Commissioning
Warranty extension



Qualification

Training
Product support



Prevention

Maintenance
Inspection



Service

Customer service
Customer consultation
HelpLine



Digital Solutions™

Remote service
Service monitor
Production monitor

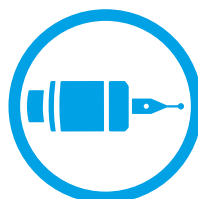

Material

Spare parts
Replacement parts
Accessories



Rebuild

Machine overhaul
Assembly overhaul



Retrofit

Modifications
Retrofits

Technical Data

Main Dimensions

Distance between centres	400 / 650 / 1000 / 1600 mm (15.7"/25.6"/39.4"/63")
Centre height:	175 mm (6.9")
Max. workpiece weight between centres	150 kg (330 lbs)

Cross slide: X axis

Max. travel	370 mm (14.6")
Speed	0,001 – 15 000 mm/min (0.000,04 – 394 ipm)
Resolution	0.00001 mm (0.000,000,4")

Longitudinal slide: Z axis

Max. travel	500 / 800 / 1150 / 1750 mm (19.7"/31.5"/45.3"/68.9")
Speed	0,001 – 20 000 mm/min (0.000,04 – 787 ipm)
Resolution	0.00001 mm (0.000,000,4")

Wheelhead

	Type: external	Type: universal
Positive stop	0/15/30 deg	
Swivel range		-30 to +210 deg
Automatic swivelling axis		3 deg Hirth
Fitting taper	dia. 73 mm (2.87")	dia. 73 mm (2.87")
Driving power:	7.5 kW (10 hp)	7.5 kW (10 hp)
Grinding wheel, Ø x width x bore	500 × 63 (80F5) × 203 mm (20" × 2.5" (3.15"F5) × 8")	500 × 63 (80F5) × 203 mm (20" × 2.5" (3.15"F5) × 8")
Circumferential Speed	up to 50 m/s (9840 sfpm)	up to 50 m/s (9840 sfpm)
Internal grinding attachment for pulley spindles		dia. 80 mm (3.15")
Speeds		28,000 / 42,000 / 60,000 rpm

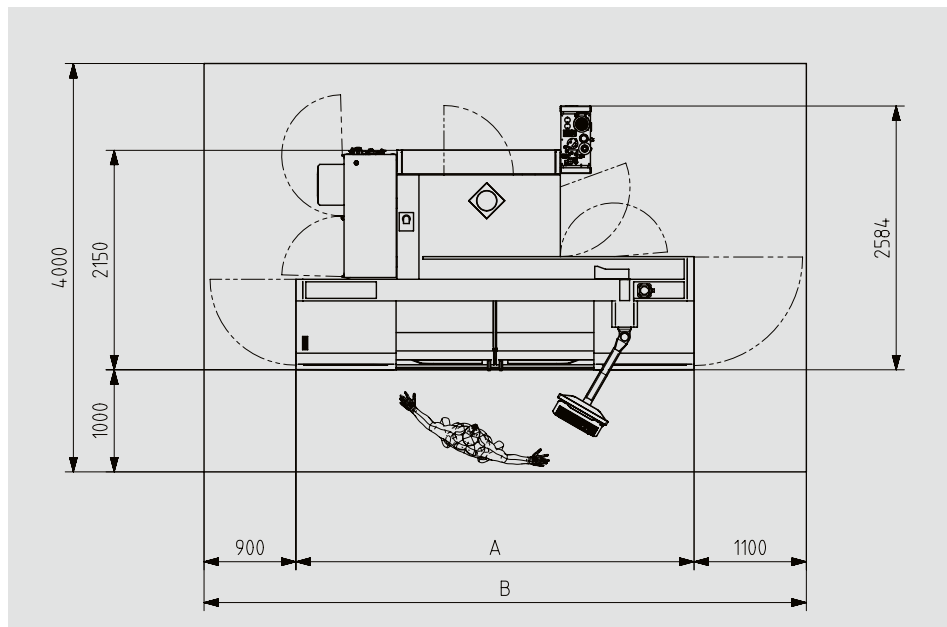

	A	B
Distance between centres 400 mm (15.7")	2200 (86.6")	4500 (177")
Distance between centres 650 mm (25.6")	3200 (126")	5200 (205")
Distance between centres 1000 mm (39.4")	3900 (153.5")	5900 (232")
Distance between centres 1600 mm (63")	5100 (201")	7100 (280")

Universal workhead

Speed range	1 – 1000 rpm	1 – 1000 rpm	1 – 650 rpm	1 – 650 rpm
Fitting taper	MT4/Ø 70 mm (2.7")	MT5	MT5/Ø 110 mm (4.3")	ISO50/Ø 110 mm (4.3")
Spindle feedthrough	dia. 26 mm (1.02")	dia. 30 mm (1.18")	dia. 38 mm (1.5")	dia. 50 mm (1.97")
Driving power:	1.8 kW (2.4 hp)	2.5 kW (3.4 hp)	1.8 kW (2.4 hp)	2.5 kW (3.4 hp)
Load during live grinding	70 Nm (52 ft lbs)	70 Nm (52 ft lbs)	180 Nm (134 ft lbs)	180 Nm (134 ft lbs)
Roundness accuracy during live grinding	0.0004 mm (0.000,016") (Option: 0,0002mm / 0.000,008")	0.0004 mm (0.000,016") (Option: 0,0002mm / 0.000,008")	0,0004 mm (0.000,016") (Option: 0,0002 mm / 0.000,008")	0.0004 mm (0.000,016") (Option: 0,0002mm / 0.000,008")

Option

C axis standard, indirect measuring system	0.0001 deg	0.0001 deg	0,0001deg	0.0001 deg
--	------------	------------	-----------	------------

Tailstock

Fitting taper	MT3	MT4	MT4
Travel of barrel	35 mm (1.37")	35 mm (1.37")	60 mm (2.36")
Diameter of barrel	50 mm (1.97")	50 mm (1.97")	60 mm (2.36")
Fine adjustment for cylindricity corrections	±40 µm (0.0016")	±40 µm (0.0016")	±80 µm (0.0032")

Control unit

Fanuc 0i-TF

Guaranteed working precision

Straightness of the surface line	
Gauge length 400 mm (15.7")	0.0020 mm (0.000,08")
Gauge length 650 mm (25.6")	0.0025 mm (0.000,10")
Gauge length 1000 mm (39.4")	0.0030 mm (0.000,12")
Gauge length 1600 mm (63")	0.0040 mm (0.000,16")

Connected load

Total connected load	20 kVA
Air pressure	5.5-7 bar (80-102 psi)

Total weight

Distance between centres 400 mm (15.7")	8500 kg (18700 lbs)
Distance between centres 650 mm (25.6")	9500 kg (20900 lbs)
Distance between centres 1000 mm (39.4")	10500 kg (23100 lbs)
Distance between centres 1600mm (63")	12000 kg (26400 lbs)

The information given is based on the technical levels of our machine at the time of this brochure going to print. We reserve the right to further develop our machines technically and make design modifications. This means that the dimensions, weights, colours, etc. of the machines supplied can differ. The diverse application possibilities of our machines depend on the technical equipment

specifically requested by our customers. The equipment specifically agreed with the customer is therefore exclusively definitive for the equipping of the machines, and not any general data, information or illustrations.



Fritz Studer AG
3602 Thun
Switzerland
Phone +41 33 439 11 11
Fax +41 33 439 11 12
info@studer.com
www.studer.com



ISO 9001
VDA6.4
certified

